

Modeling Megacity Medical System Response to a CBRNE Event

Dr. Kenneth McDonald¹, Tyler McLees¹, Shane Connolly¹, James McNulty¹, Leah Wasserman¹,
and LTC Robert Prins²

¹Department of Systems Engineering
United States Military Academy
West Point, NY

²Nuclear Science and Engineering Research Center
United States Military Academy
West Point, NY

Corresponding author's Email: Kenneth.McDonald@usma.edu

Author Note: Authors are associated with the Center for National Reconstruction and Capacity Development, Department of Systems Engineering at the United States Military Academy. Thank you to NSERC for supporting this project and to Dr. Larry Dauer for his time spent on interviews with us in order to fully understand the hospital system of New York City and their emergency plans. Thank you to FEMA, OEM, VA, and HHS for time spent on interviews with us which were essential to the understanding of the emergency response system of New York City. Parts of this paper were previously published and presented in the Donald R. Keith Memorial Capstone Conference at USMA in May of 2016.

Abstract: The collaborative effectiveness of the public health system (PHS) and the Army Medical Department (AMEDD) is limited in the case of a 10-kiloton (kt) nuclear event on a megacity due to an overall lack of knowledge and understanding among agencies. This study details an exhaustive analysis of the current medical response system using New York City as a case study. Through the problem definition phase of the Systems Decision Process (SDP), this report identifies operational gaps existing at different levels within the system. Identified operational gaps existed at the local, state, and federal levels in the areas of resources, communication, and planning within the following agencies: Sloan Kettering Memorial Hospital, the Office of Emergency Management (OEM), the Federal Emergency Management Agency (FEMA), Health and Human Services (HHS), and the United States Department of Veteran Affairs (VA). Evaluation of the operational gaps illustrated the areas which were most vulnerable. The current analysis suggests that the system in place requires adjustments of the identified gaps so that maximum efficiency can be achieved.

Keywords: Megacity, CBRNE Event, (Chemical, Biological, Radiological, Nuclear and Explosive), Army Medical Department, Emergency Operations Center, Public Health System, Gap Analysis, Systems Dynamics Modeling, Value Modeling, Modeling, Assessment, Metric Analysis, Systems Decision Process

1. Introduction

Megacities hold strategic importance for local, national, and international actors. Without a coordinated consequence management plan, an attack on a megacity would be tragic with respect to number of casualties as well as regional stability. A chemical, biological, radiological, nuclear, or high yield explosive (CBRNE) event in today's environment will have catastrophic implications for local, national and international actors. To effectively prepare for a catastrophic event, planning must exist at the local, state, and federal levels with consideration of second and third order effects. A large scale CBRNE event can result in enormous loss of life, a constrained national budget, and political instability in key geographic regions of the world. (Agency, 2015) Due to the complex nature of the threat of a CBRNE event, it is necessary to begin planning for the aftermath of an attack in order to ensure that resilient systems are set in place that will minimize the disruption of daily activities within cities.

CBRNE events can have a tremendous impact on highly urbanized areas. Due to their dense populations and interconnectedness, megacities create complexities that make contingency planning much more difficult than other areas. Megacities also serve as major economic centers and make up the epicenters of most of the world's gross domestic product (GDP). The focus of this research is to assess the Public Health System (PHS) and the Army Medical Department (AMEDD) capabilities in order to plan for a resilient medical system that is prepared to respond in the aftermath of a 10 kt nuclear event.

This research uses systems thinking to bridge the gap between PHS and AMEDD. The systems thinking framework is defined through the Systems Decision Process (SDP) (Figure 1). The SDP is a collaborative, iterative, and value-based decision process that can be applied at any stage in a system’s life cycle. (Parnell, Driscoll, & Henderson, 2010) Since major decisions involve constant allocations of resources, it is important to have a logically consistent and proven process to assist major stakeholders in making decisions. The SDP also allows systems engineers the ability to use value-focused thinking. Value-focused thinking involves the strategic process where input from stakeholders and subject matter experts determine the parameters for success. The success metrics then drive the development of the solution and evaluation of candidate solutions. This flexibility allows the SDP to be effective for a wide scope of systems.

This research serves to identify gaps within the consequence management planning and execution at the local and federal levels in order to help governing actors develop seamless, efficient consequence management systems. This was accomplished through a systems approach that used New York City as a case study. New York City has fallen victim to catastrophic events multiple times over the last two decades (9/11, Hurricane Sandy, etc.). In response to such events, New York City utilized its emergency systems at every level. As a highly modern and developed megacity, New York City’s response to catastrophic events should serve as the model for medical response in other cities. The use of New York City as a case study provides understanding of New York City’s consequence management planning and execution. This research focuses on the impact of a 10kt nuclear event detonating in lower Manhattan. Through exhaustive analysis, this project identifies the major operational gaps existing within the medical response system and highlights their consequences. Sections can be further divided into subsections with headings.

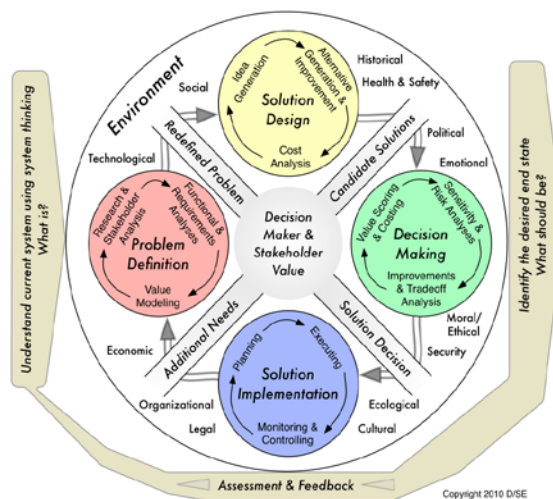

Figure 1. Systems Decision Process (Parnell, Driscoll, & Henderson, 2010)

2. Methodology

A large CBRNE event will have catastrophic implications for local, national and international actors. A large scale CBRNE event can result in enormous loss of life, a constrained national budget, and political instability in key geographic regions of the world. (Agency, 2015) Due to the complex nature of the threat of a CBRNE event, it is necessary to begin planning for the aftermath of an attack in order to ensure that resilient systems are set in place that will minimize the disruption of daily activities within cities.

CBRNE events can have a tremendous impact on highly urbanized areas. Due to their dense populations and interconnectedness, megacities create complexities that make contingency planning much more difficult than other areas. Megacities also serve as major economic centers and make up the epicenters of most of the world’s gross domestic product (GDP). This research uses systems thinking to bridge the gap between PHS and AMEDD. The SDP is a collaborative, iterative, and value-based decision process that can be applied at any stage in a system’s life cycle. (Parnell, Driscoll, & Henderson, 2010) Since major decisions involve constant allocations of resources, it is important to have a logically consistent and proven process to assist major stakeholders in making decisions. The SDP also allows systems engineers the ability to use value-focused thinking, which involves the strategic process where input from stakeholders and subject matter

experts determine the parameters for success. The success metrics then drive the development of the solution and evaluation of candidate solutions. This flexibility allows the SDP to be effective for a wide scope of systems.

The SDP encompasses the evolution of the system state, beginning with the current state, and ending with what the system will deliver to the user. Within the problem definition phase the systems engineer gains a basic understanding of the current state of the system. This is accomplished through stakeholder and subject matter expert interviews, functional analysis as well as value modeling, which leads to a greater in-depth understanding of the dynamics between actors within PHS. To accomplish this, key stakeholders and subject matter experts from each organization were questioned to piece together the puzzle that is the emergency response system and how best to integrate AMEDD within any existing gaps. Some of the organizations that play a key role include: AMEDD, Public Hospitals, the National Nuclear Security Administration (NNSA), the Federal Emergency Management Administration (FEMA), the Office of Emergency Management (OEM), and the Department of Homeland Security (DHS). Within the functional hierarchy, five fundamental functions were identified as essential to get from the current state to the desired end state. They are: Identify the capabilities of a 10 kt nuclear weapon, an exhaustive analysis of the PHS, an exhaustive analysis of AMEDD doctrine, identifying additional emergency support organizations, and finally the integration of AMEDD into PHS response.

With a clearer understanding of the problem, the research focused on the solution design phase. A gap analysis was completed which found major shortcomings in several areas of emergency response. System dynamics was applied to these gaps to gain a more detailed in-depth understanding of what is happening in the system. The inefficiencies in the PHS' medical response to a 10 kt nuclear attack as well as AMEDD's capabilities have been identified. This is where recommendations are made to adjust doctrine in order to create a complete, cohesive system that is prepared to respond to a crisis.

The SDP is a logically consistent and proven process that follows a system from its current state to its desired end state. Use of the SDP provides a framework for making key decisions at any stage in the systems life cycle. Megacities are currently unprepared for a major CBRNE event because there are too many unknowns that exist within consequence management and emergency planning. This project serves to seek out those unknowns through an exhaustive analysis of PHS and AMEDD to improve emergency response plan.

3. Background

Since the Cold War, the possession and capabilities of CBRNE delivery systems have played a large role in shaping foreign policy and resulting in tensions between nations. These types of weapons have the capability to produce mass casualties as well as cause extreme disruption to societies. (Department of the Army, 2014) As the war on terror continues, increasing accessibility to these weapons calls for an increased need to be prepared in the event of a potential attack. There is no way to determine what type of CBRNE attack may occur, so having the flexibility to respond to any type is crucial in order to limit casualties. While a policy of deterrence and arms control was the preferred method of limiting the power of developed countries, such a policy would prove ineffective in a changing international scene. (Betts, 2012) Today, CBRNE weapons are not symbols of national strength—they are now largely used by nations or groups which are not militarily adept. (Jindal & Roy, 2014) Therefore, it is important to devote efforts towards creating a comprehensive consequence management plan for a CBRNE event.

While the first order effects of a potential CBRNE event are well understood by the Army and the National Command Authority (NCA), it is important understand the second and third order implications of such events. One major piece to this puzzle is the knowledge of the medical resources needed in the event of an attack in a megacity. In cases of megacities, operations dealing with public health are more complicated than in other areas. An important aspect of developing a comprehensive consequence management plan is to understand the current capabilities of the public health care system, particularly in regards to educational training programs, access to CBRNE specialists, and the logistical efficiency of the PHS. The importance of megacities in global infrastructure, combined with the complex nature of the PHS within megacities and the variety of devastating effects that a CBRNE event can cause, make large cities more likely to be targeted. The PHS is ill-equipped to meet the demands that would be placed on it if a CBRNE event takes place.

3.1 Megacities

A megacity is defined as a city with a population of ten million or more people. (Harris, et al., 2014) There are approximately twenty megacities in the world today and that number is predicted to grow to forty by 2025. From 1900 to 2005 the amount of people living in cities grew from 13 percent to 49 percent of the population. (Command, 2007) The number of people living in cities is growing exponentially, with 220 million in 1900 to 3.2 billion in 2005 and potentially 4.9 billion in 2030. The rapid urbanization of society is a salient concern for governing authorities because it makes megacities a

target for those who seek to create instability. They are a high-value target because megacities hold such an important function in world affairs. As the population within megacities grows, the dependence of the world economy on megacities grows with it. By 2030 it is estimated that 70 percent of the world's GDP will exist within megacities. (Harris, et al., 2014) Megacities that exist in Europe, North America and Japan are especially important because they have developed into command and control centers for the international economy. (Parker & Tasell, 1995) A large scale disaster in a city such as London would significantly hinder the world's financial market.

Megacities can be broken down into three "archetypes:" Emerging, Transitional, and Mature cities. They are ranked in order of development and stability with Mature being the most developed and stable and Emerging being the least. Emerging cities are characterized by high growth rates (between 3 and 6%). A 3.5% growth rate turns out to a doubling in population over the course of twenty years. (GlobeScan & Hazel, 2007) Some examples of the population growth within Emerging cities between 1970 and 2000 are Bangalore (1.6 – 5.7 million), Bogota (2.3 – 6.7 million), and Sao Paulo (7.6 – 17.1 million). (Kraas, 2007) They also have high social polarity, large gaps in wealth, as well as poor healthcare and education. Transitional cities generally have slowed natural growth rates, with much of the population growth coming from migration. They face many of the same problems of Emerging cities, but are better prepared to respond due to their infrastructure and financial capability. Mature cities have much slower growth rates (around 1%), and have already developed the infrastructure and society to a level that allows the city to run efficiently.

3.2 Importance

Megacities are a topic of concern because of the global dependence on them, but because they are becoming increasingly difficult to monitor. These cities pose much more complex disaster relief issues because: events with a low area of impact may still affect a large number of people; awareness of the disaster spreads more rapidly without a medium to filter correct information; and the information quickly reaches outsiders via mass media outlets. (Kelly, 1995) City populations are growing at a faster rate than the infrastructure can sustain. Many of the people who move to these cities are subjected to poverty, disease and are more likely to be victims of crime. The interconnectedness of the people of these cities, combined with the growing gap between citizens and police force allows potential terrorist groups more freedom of maneuver in conducting operations. These poor, underfunded areas limit the state's capacity to address grievances and control terrorist groups. For example, Lagos, Nigeria is currently listed as the sixth largest megacity in the world. (Obono, 2007) In 2006 the state had \$650 million in funding for its 15 million people compared with New Delhi who had \$2.6 billion for its 13.8 million people. This makes megacities like Lagos an essential hideout location for terrorist organizations who may be pursuing CBRNE weapons. Analyzing an emerging megacity like Lagos provides information that can be utilized in mature megacities, like New York. Areas in New York are also underfunded, and there is a high civilian to first responder ratio which makes it difficult to monitor potential attackers.

3.3 Strategic Interest

The importance of megacities cannot be understated. The Chief of Staff of the Army's strategic studies group claimed that key strategic terrain will continue to be located within megacities into the future and it is important to ensure stability within megacities in order to continue global connectedness and order. Some megacities are important due to their proximity relative to areas of strategic interest. Cairo, Egypt and Karachi, Pakistan all hold unique positions in the vicinity of current and potential future U.S. operations. Tokyo, Japan and Shanghai, China will rank in the top 5 of the cities with the largest GDP in 2025, and Lagos, Nigeria is the largest oil producing country in Africa and is home to deep water ports where most of Nigeria's oil exports travel through. (Harris, et al., 2014)

As a stakeholder in world affairs, the U.S. is a large contender in spearheading the new security forces. The problem is that current U.S. Army doctrine does not account for conducting operations within a megacity. Field Manual (FM) 3-06 sees a city as a "large area of operation," and doesn't distinguish between cities and megacities. Megacities are different than cities because a megacity cannot be physically isolated, where isolating and shaping the surrounding environment is the critical task while operating in a city. Keeping the scheme of maneuver the same for megacities puts commanders in a position where they would have to control millions of people across hundreds of square miles. In recent history, the Army has operated in Baghdad, a city of approximately 6.5 million people, which will be quite small than the estimated 37 cities that are 200-400% larger than Baghdad by 2030. (Harris, et al., 2014)

3.4 Impact

Along with an increased knowledge of the role of megacities in global infrastructure, a thorough understanding of CBRNE capabilities is vital to understanding how a CBRNE event will stress a megacity's emergency response. Whether a

CBRNE incident that occurs is intentional or by accident, the effects on a megacity are generally the same. CBRNE incidents may include all or some of the following potential characteristics: mass casualties, loss of life, long term health effects, an extremely hazardous environment, need for immediate medical treatment for mass casualties, need for timely and efficient and effective mass decontamination systems, and need for pre-coordination within health services to establish medical treatment protocols. There is also the potential use of a combination of CBRNE materials each presenting different response requirements thus complicating and pressuring an overtaxed emergency response system. (Kollek, Welsford, & Wanger, 2009)

3.5 Weapon Types

New forms of CBRNE weapons and delivery systems are unlikely to emerge anytime soon in the near future. (Caves & Carus, 2014) In the coming years, through the use of technology, individuals or groups will have greater access to CBRNE weapons. There will be lower obstacles to the covert development of more sophisticated nuclear weapons. Chemical and biological weapons are likely to be more accessible and more capable in defeating defensive countermeasures. (Caves & Carus, 2014) This leads to the possibility that nuclear weapons will not change technologically from what they are today, but the use of chemical and biological weapons may increase or be more expected because of their capability in defeating defensive countermeasures. A destructive device is an explosive, incendiary, poison gas, bomb, grenade, or rocket that has the ability to expel a projectile. (Kelley, 2012) Any component of CBRNE used or employed in any form mentioned is considered a weapon, potentially of a large magnitude.

There are four major types of chemical attacks: blister agent (mustard agent), toxic industrial chemical, nerve agent, and chlorine tank explosion. Blister agent is a gas, which damages the respiratory system and produces serious burns. Exposure to high levels is fatal. (Historical Department, 2007) Mustard agent has the ability of being quite lethal in a concentrated population. There are only limited medical treatments available for victims of mustard agent poisoning. There are wide ranges of toxic chemicals that can be used in large quantities to compensate for their lower toxicity. Chlorine fumes are similar to those of mustard agent and produce similar effects. However, these are much less toxic, but medical treatments are similar to treating nerve agents. Nerve agents are the most toxic and are the most rapidly acting agents. The most common nerve agents include Sarin, Tabun, Soman, and VX, which are all highly toxic and disrupt a victim's nervous system by blocking the transmission of nerve signals. When released these agents contaminate the area quite extensively and will lead to death. (Historical Department, 2007)

The main biological agents are Anthrax and Ricin. Anthrax is capable of causing mass casualties and is usually fatal unless antibiotic treatment is started within hours of inhaling the spores. Because Anthrax acts relatively quickly, one can imagine in a densely populated megacity it would be very difficult to begin antibiotic treatment for the masses of people effected. Possible delivery systems for anthrax are by aerosol or by food contamination. Ricin is 30 times more potent than the nerve agent VX and there is not treatment for Ricin poisoning once it has entered the bloodstream. (Historical Department, 2007)

A radiological attack is usually accomplished through a radiological dispersal device (RDD). A RDD is a conventional weapon that is designed to disperse radioactive material. This will cause destruction, contamination, and injury from the radiation produced by the material. It can be any amount of radioactive material. Use of an RDD will result in health, environmental, economic and social effects. It will lead to levels of contamination that will cause death as well as timely and costly cleanup and follow-on treatment. (Cordesman, 2001)

A nuclear explosion can be many times more powerful and destructive than a conventional detonation. The energy from a nuclear explosion will produce a tremendous blast, which will lead to immediate destruction of all structures, extreme burns, fires and radiation, which remain dangerous over extended periods of time. Wind speeds created due to a nuclear explosion, have the ability of reaching upwards around 900 miles per hour instantly destroying anything in the blast radius. (Rossenfeld, 2015) A nuclear detonation from a 10 kt bomb would cause a crater with a radius of 80 meters and a destructive force radius of one kilometer. The radiation from a nuclear bomb of this size would lead to third degree burns up to 2.5 km away. To give a better idea of what this impact might affect, Figure 2 depicts the direct radius and outward effects of a 10-kt detonation. Based upon the Nukemap model of New York City, the estimated number of injuries is 213,430 people with 103,000 fatalities. (Wallerstein, 2016)

High yield explosives have a major impact on infrastructure. High yield explosives do not have the medical implications that come with the fallout of a nuclear detonation. Reaction to high yield explosive events should be directed towards stabilizing the system while ensuring the proper medical treatment reaches the site in a timely fashion. Casualties from a high yield explosive attack may be treated at a broader range of facilities than other types of CBRNE attacks. Because treatment is more general than specific like radiation poisoning which would require very specialized equipment to treat.

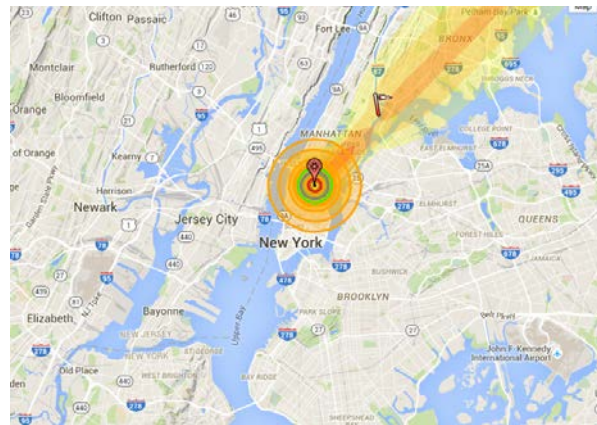

Figure 2. Map of NYC, 10-kt Nuclear Blast (Wallerstein, 2016)

3.6 Public Health

The PHS obviously has a tremendous role within emergency response to a CBRNE event. The study of the PHS is inherently reliant on social sciences. (Khan & Pappas, 2011) Infrastructure recovery is also key to the survival of a city after a CBRNE event making the two inter-related. (Lorrain, 2014) The PHS is deeply rooted in data collection, the tracking of disease outbreak, and laboratory investigation. In the early twentieth century, the U.S. public health department focused on fighting chronic disease because it was the leading cause of mortality in the U.S. Later in the century, this duty moved out of the hands of activists and into those of individual physicians. (Rosner & Markowitz, 2006) Prior to 9/11, the PHS served primarily to combat disease. With threats of bioterrorism, chemical, and other attacks growing in the twenty-first century, PHS expanded its mission to keeping the population safe from such attacks. From 2001 through 2003, the role of PHS turned from a general service to a component of national defense. In the years following 9/11, officials feared the focus of public health would shift too far. Officials feared that a focus on public health in terms of national defense would take away from the original, broader mission to provide services to the general public. PHS relies on government funding and rules; therefore, the priorities of public health vary from city to city and state to state. Money that goes into the PHS is directed to emergency and disaster preparedness in addition to general services. (Rosner & Markowitz, 2006)

3.7 Challenges

There are several social challenges associated with megacities which make them more prone to public health problems in comparison to other urban areas. These social challenges make megacities vulnerable due to their composition and behavior. The first challenge is population size and density. For example, New York City contains two fifths of the population of the entire state of New York. (New York City, 2016) To care for this population, the city lists eleven public hospitals currently, averaging three per borough. Due to rapid growth of the populations of megacities and other heavily populated urban areas, the populations of these cities outgrow the administrative and infrastructural capabilities of the cities. (New York City, 2016) Tier three megacities' populations expand at a much faster rate than those in the first tier. For example, Mumbai is expected to increase by over 7.5 million people by 2025 while it took New York City fifty years to grow by five million. This makes the possibility of outgrowing capabilities more of a threat in lower tier megacities. The other challenges include geographic size, social dispersion and emergency response training. (New York City, 2016)

While growth may be more stable in first tier megacities, population size still presents a major challenge for the PHS. Population size and density leads to public health specific problems in the areas of infectious disease, food and water supply problems, and pandemic risk. (Khan & Pappas, 2011) Infectious disease and pandemic risk go hand in hand. In the concentrated populations of megacities, disease is more likely to spread. In 1990, the hospitals of New York City were overwhelmed by the outbreak of HIV and AIDS. Twenty-five percent of the nation's AIDS cases were concentrated in New York City. AIDS patients took up ten percent of hospital space in 1990. (United States Congress House Committee on the Budget, 1990) Congressman Charles Schumer, Chairman of the Task Force on Urgent Fiscal Issues, claimed that none of the city's sick could count on being treated in public hospitals. This dysfunction relates in a CBRNE emergency because one can conclude that in the case of a chemical or biological attack, casualties could potentially spread in a similar manner as an infectious disease. In the AIDS case, New York City required federal help in order to maintain a proper level of care for

hospital patients. This did not function as well due to independent institutions attempting to contribute to urban policy. Due to large and diverse populations, megacities are likely to be focuses of both private institutions and non-governmental organizations, especially in case of emergencies. Megacities challenge the role of traditional governance due to the addition of various players into the system. (Lorrain, 2014) Relationships between public and private institutions on local, state, and federal levels are key to the administration of a megacity. However, if these roles are not identified and practiced, it leads to dysfunction.

Extremely large populations are an issue for public hospital capacity in cases of emergency, but simply identifying population size is also a challenge. There are multiple potential situations in a megacity where all of the people living within the city would not be properly counted. An example of this problem is Karachi, Pakistan. In 1998 the census count was off by approximately two million people. Those not counted were either Afghans or Bengalis and therefore they were incorrectly assumed to not consume Pakistani resources. (Kraas, 2007) While this may or may not be a big challenge for everyday type things, in cases of emergencies, medical personnel would be expected to treat all residents of a megacity, not just those legally counted. Without properly identifying a population, the medical system cannot adequately prepare for emergencies. This challenge is relevant to the U.S. in terms of illegal immigration and homeless people. While they may not be counted in the official population, they should be accounted for in matters of the PHS in order to react properly to a CBRNE emergency.

A megacity's geographic size is an important consideration. The major challenge here is delaying services and medical care. Roads and other transportation systems are not capable of operating at the pace which the population needs. In some cases, normal weather occurrences, events heard in the news, or even daily commuters can cause standstill traffic for hours at a time. These conditions and overwhelming population leads to delays for emergency personnel. (Kraas, 2007) During 9/11, one group of emergency medical services (EMS) dispatchers should have been responsible for only the Manhattan south borough area, but due to technical difficulties one dispatcher was covering both south and central areas. The first plane struck the World Trade Center at 0846 and by 0853, the first responding EMS officer had been established. The Assistant Chief of EMS Operations arrived by 0901 and assumed EMS command. At 0907, EMS recognized the state of emergency and requested help from the New York region. By 0930, EMS responders and the FDNY were coordinated and had established command and control of the situation. Communication between EMS officers was difficult due to beyond average radio traffic which was an effect of the gravity of the incident and the size of the population affected. This was also partially due to the way that the EMS used one frequency for two different communication channels. At 0945, another radio channel was opened in order to ease communication. EMS was also responsible for tasking ambulances to medical emergencies. They were not capable of responding to the high volume of calls and had limited ability to synthesize information and work effectively. The attacks resulted in use of thirty percent of available ambulances and 24 of 31 EMS lieutenants and captains on duty. Organizational methods used by emergency services, such as magnetic boards to keep track of deployments, proved useless in the case of this severe emergency. Throughout the day, emergency services lost and regained control of the situation due to overwhelming information and requirements. (Company, 2002) They had tremendous difficulty due to the size of the population and emergency.

Integration and dispersion is another social determinant of health risks. This includes but is not limited to: social inequalities, social isolation, feminization of poverty, relaxation of social supervision, and criminality. (Kraas, 2007) Social disparities translate to health disparities among the cities' populations. Megacities are hubs where lifestyle change is accelerated, but this change is not uniform across the population. History has shown that it is not socioeconomic disparity that determines who lives or dies in cases of health crises in major cities, but rather the lack of social networks. This was the case for the 1995 heat wave in Chicago and the spread of Hepatitis C. The challenge here was getting adequate information to the different populations. (Lorrain, 2014) The uniformly distributed spread of information is uncommon in megacities due to the differences among various sectors of the city and peoples of the population. Lack of networks between different pieces of the massive population translates to a lack of proper information dissemination in case of emergency.

Focus on preparing consequence management strategies is important for the success of a megacity in the case of a CBRNE event. It is not possible to plan for all contingencies, but realistic exercises are vital to the success of the response to a CBRNE incident. Domestically, national level exercises like these are conducted multiple times a year in order to make involved organizations work through inefficiencies that precipitate from cooperative efforts. (Heffelfinger, Tuckett, & Ryan, 2013) This will make the actual emergency response more effective in dealing with the problem with little inefficiency. One consequence management tool which is available for use by health care professionals is a table-top exercise card. These cards, developed by the Swedish Defense Research Agency, are intended to decrease the detrimental impacts on health and reduce psychosocial effects of a CBRNE event through an exercise which addresses preparedness, acute responses, and mitigation efforts for a set of adaptable scenarios stemming from real-world incidents. (Sandstrom, Erksso, Norlander, Thorstenson, & Cassel, 2014)

The PHS has in place an emergency response program that is utilized every day. Within the context of CBRNE exposure, the police and fire department will deal with quarantining the site of detonation and the PHS will be free to treat patients who have been exposed to the contaminant. The PHS is well-versed in procedures relating to the treatment of a

CBRNE victim, to include emergency response, anesthesia, specialist care, and follow-on care. (Barash, Cullen, Stoelting, Cahalan, & Stock, 2011) The issue of dealing with a CBRNE attack will lie in the number of people needing care and the relative scarcity of health care facilities. Training for these events is problematic. It is time consuming, expensive and there are interagency difficulties. Funding for such events are limited especially when results do not show until an actual CBRNE event occurs.

3.8 Army

The events of 9/11 changed the landscape for the U.S. in regards to responding to CBRNE events. Consideration is given to expanding roles to leverage all the capabilities of the U.S. Government. One area is the Department of Defense (DOD). In identifying the capabilities of the PHS, it is important to note the contributions of the Army to these efforts. When the DOD was directed to eliminate Iraqi weapons of mass destruction (WMD) in 2003, they faced several capability gaps due to lack of doctrine, training, communication, and equipment. The 20th CBRNE Command was activated on 16 October 2004 in order to provide support to the dynamic threats that arise from the development of WMDs. Today, the 20th CBRNE Command operates with over five thousand soldiers and civilians in sixteen states in the continental U.S. Their mission is:

“The 20th CBRNE Command (Chemical, Biological, Radiological, Nuclear, Explosives) integrates, coordinates, deploys, and provides trained and ready CBRNE forces. Capable of exercising command and control of specialized CBRNE operations to support joint and Army force commanders primarily for overseas contingencies and warfighting operations, but also in support of homeland defense. Maintains technical links with appropriate joint, Army, Federal and State CBRNE assets, as well as the research, development, and technical communities to assure Army CBRNE response readiness.” (20th CBRNE, 2016)

Domestic Chemical, Biological, Radiological, and Nuclear Consequence Management

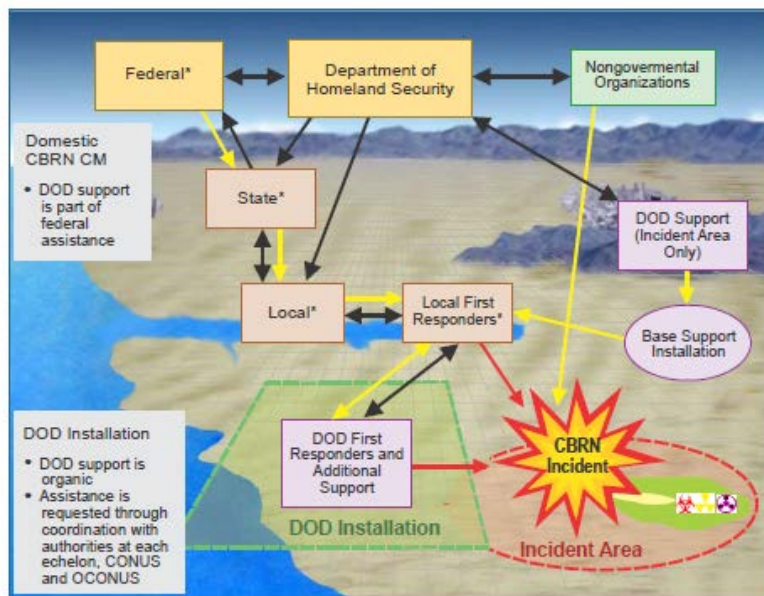

*Tribal response may require special consideration during coordination.

Legend

CBRN	chemical, biological, radiological, and nuclear	
CBRN CM	chemical, biological, radiological, and nuclear consequence management	←→ request for assistance/coordination
CONUS	continental United States	→ provision of assistance
DOD	Department of Defense	←→ response to incident
OCONUS	outside the continental United States	

Figure 3. Domestic CBRNE Consequence Management (20th CBRNE, 2016)

While the active Army houses the 20th CBRNE Command, the number one priority of the 20th CBRNE Command is working in coordination with domestic units in order to prepare to deploy to respond to a CBRNE event outside of the U.S. Therefore, the DOD has developed the CBRNE Consequence Management Enterprise in order to support disaster response agencies at the federal, state, and local level. This enterprise includes National Guard assets of fifty-seven WMD civil support teams, seventeen enhanced response force packages, and ten homeland response forces. These units act under the DOD only upon request by an appropriate authority and after approval of the Secretary of Defense. When conducting CBRNE response in accordance with the National Response Framework (NRF), the DOD is in support of an NRF emergency support function primary agency or NRF. As a practical matter, DOD prefers a single source for mission assignments and generally identifies the Department of Homeland Security's (DHS) Federal Emergency Management Agency (FEMA) as the primary agency in its operation order (OPORD) authorizing federal military assistance. The interaction between federal, state, and local agencies is shown in Figure 3. The long-term health efforts will include two basic functions: Addressing the extensive long-term health effects which are associated with CBRNE exposure, and decontaminating the attack site so that it is safe to use again. (Chairman of the Joint Chiefs of Staff, 2012)

FM 3-11.5 outlines the process through which military units decontaminate CBRNE sites. In it, there are plans put in place for decontamination of specific sites, an introduction to the equipment used by each service, decontaminants, and logistics. FM 3-11.5 discusses the standard operating procedures that would accompany different types of decontamination efforts. A decontamination support diagram illustrating this system is shown in Figure 4. (Department of the Army, 2005) JD 3-41 and FM 3-11.5 helps to explain the capabilities of the Army in assisting in the PHS.

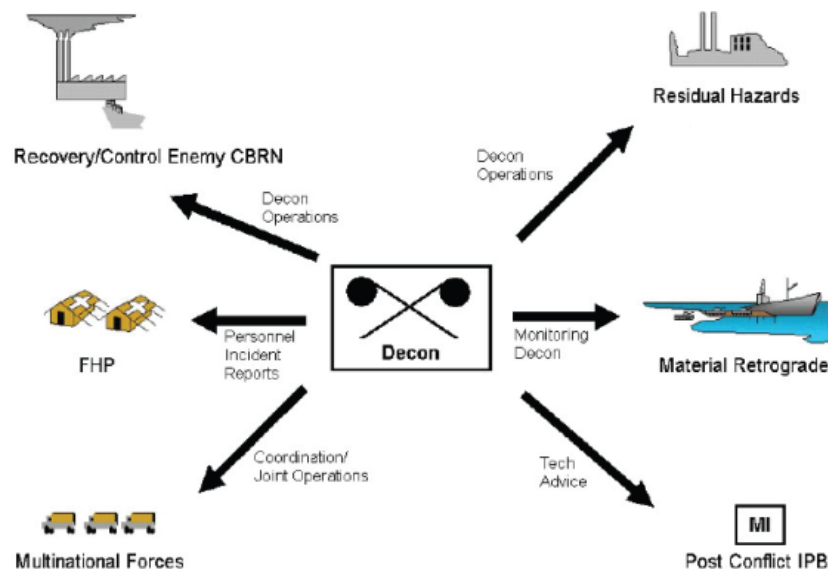

Figure 4. Decontamination Support (Department of the Army, 2005)

3.9 Process

The military would most likely be incorporated to a large-scale CBRNE event. The event will begin with local authorities involved in a 10-kt nuclear event. In this case, the local authorities would notify the Federal Bureau of Investigation (FBI), who would respond by sending a WMD coordinator to the scene of the attack in order to develop a unified command structure with the incident commander. As stated previously, the DOD would support the leading federal agency in their response by using all necessary available assets. However, in the case of a 10-kt event, local authorities have probably been compromised and the response would probably fall on federal authorities. The President would invoke the Insurrection Act and Immediate Response Authority, which gives the DOD authorization in order to “save lives, prevent human suffering, or mitigate property damage”. Further involvement will depend on the scale and complexity of the incident. (Heffelfinger, Tuckett, & Ryan, 2013)

To add to the complexity of this are several military agreements which affect the U.S.' consequence management plan. They include:

1. Canada-US Civil Assistance Plan - This plan provides a framework for mutual support if there is a need for civil support operations.
2. North American Treaty Organization (NATO) Standardization Agreements – Establishes common equipment, military and technical requirements, methods and procedures.
3. Security and Prosperity Partnership of North America - The SPP agreement was signed on 23 March 2005 by the President of the U.S., the Prime Minister of Canada, and the President of Mexico. It incorporates a bi-national objective on emergency management cooperation to develop and implement joint plans for incident, as well as conduct training exercises. (Chairman of the Joint Chiefs of Staff, 2012)

There are several laws and U.S. Codes which affect the U.S.' consequence management plan. They include:

1. Posse Comitatus Act - Statute which limits the use of federal military personnel to perform civilian law enforcement activities. Specifically prohibited activities include interdiction of a vehicle, vessel, aircraft, or similar activity; search and/or seizure; arrest, apprehension, "stop-and-frisk" detentions, and similar activities.
2. Title 10, USC (Armed Forces) - prohibit "direct participation by a member of the Army, Navy, Air Force, or Marine Corps in a search, seizure, arrest, or other similar activity unless participation in such activity by such member is otherwise authorized by law."
3. Title 32, USC (National Guard) - authorize the use of federal funds to train NG members while they remain under the command and control of their respective state governors. In certain limited instances, specific statutory or Presidential authority allows for those forces to perform operational missions funded by the U.S. Government, while they remain under the control of the governor. (Chairman of the Joint Chiefs of Staff, 2012)

An important distinction to make through this process is that National Guard units are less restricted by both the Posse Comitatus Act and the Title 10 US Code allowing them greater flexibility in assisting state governors in the event of a CBRNE attack. (Heffelfinger, Tuckett, & Ryan, 2013)

Diagnosing the shortcomings of the consequence management system is difficult. Primarily, it is difficult to identify the challenges which will arise in the event of a large scale CBRNE event because such an incident has not yet occurred. The strain that will be placed on the consequence management system will be extreme due to the sheer number of people affected. This strain is amplified by the complexity of the system, having to take into account first response efforts, emergency health care, sustained health care, decontamination efforts, food and water supply, and psychological care.

The largest unknown variable, which poses a challenge to the consequence management system, is the public response to a CBRNE event. It is important to acknowledge that the public plays an active role in CBRNE management and is not just a bystander obeying the orders of PHS professionals. Figure 5 illustrates the complex nature of a CBRNE event on people. There will be emotional reactions by society to the CBRNE event which need to be considered. The general lack of knowledge surrounding a CBRNE event evokes a strong emotional response by members of the public. This can often impact the relationship between the public, the local and state institutions. The four perceptions which shape the public response to CBRNE incidents are: the threat; the emergency situation management actors; the actions of those actors; and the actors' efforts to address public perception and information needs. (Krieger, Amlot, & Rogers, 2014) The bottom line here is that the response of people to these events are quite unpredictable.

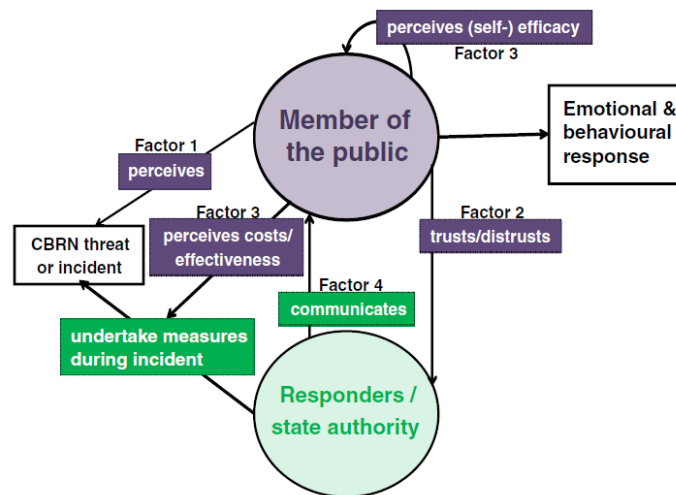

Figure 5. Factors Affecting Emotional and Behavioral Response (Krieger, Amlot, & Rogers, 2014)

Megacities undoubtedly hold significant importance to the U.S. and their allies. Megacities are a focal point of the international economy and a staple to maintaining global security. With huge numbers of people living in such close proximity, megacities are especially vulnerable to CBRNE attacks by those who have a stake in destabilizing society. With all the different aspects of CBRNE weapons and the destructive capabilities of each type, there is a wide spectrum of how a megacity may need to respond to a CBRNE event. Creating hazard response plans within megacities is a paramount issue for the U.S. These plans need to be general enough to respond to each type of CBRNE event, while at the same time adaptable to address the destructive effects each specific type of CBRNE agent. Current dysfunctions of the PHS in megacities are key to analyzing the operations of the medical system. It is imperative that the U.S. have in place a comprehensive consequence management plan in order to maximize the effectiveness of an emergency response force in responding to a CBRNE event. As a large piece of the hazard plan, the U.S. Army needs to update its doctrine and prepare itself for operations within megacities. Megacities will continue to grow as areas of interest and will continue to require greater research and analysis in order to maintain global stability. The complexity of the situation will call for interagency cooperation with an emphasis on communication with the public in order to allow the PHS and DOD to act in a manner that will expedite the immediate response and streamline the prolonged response to such incidents.

4. Analysis

A method for illustrating how the current system runs is a systemigram. A systemigram is the graphical representation of how the current system interacts with other systems (Boardman, 2008). In the case of a megacity, defining the boundaries of the system is important due to the dynamic nature of infrastructure in densely populated areas. The systemigram associated with a nuclear attack on a megacity is shown in Figure 6. This gives a clearer understanding of how the infrastructure of a megacity is affected by a nuclear attack. For example, the digital infrastructure of a megacity constrains the medical infrastructure due to the importance of technology in administering care.

An important note concerning the systemigram is that the CBRNE event is the focal point of the response structure. The severity, location, time, and other factors surrounding the attack dictate the entire response framework. The systemigram also illustrates the complexity of the system. For example, the digital infrastructure in the systemigram is defined as a city's ability to provide reliable sources of communication and power to constituents. A stress placed on the digital infrastructure limits the medical system's ability to do its job. This is due to organization's heavy reliance on technology to treat and track patients in a highly dynamic system. It also impedes their ability to communicate which complicates their ability to request and receive assistance. Similarly, the resources and systematic processes for response available to the megacity dictate the need for government assistance. Since no two megacities are the same, the process for response will not be uniform, but rather an adaptable series of processes that can be adjusted based on the context.

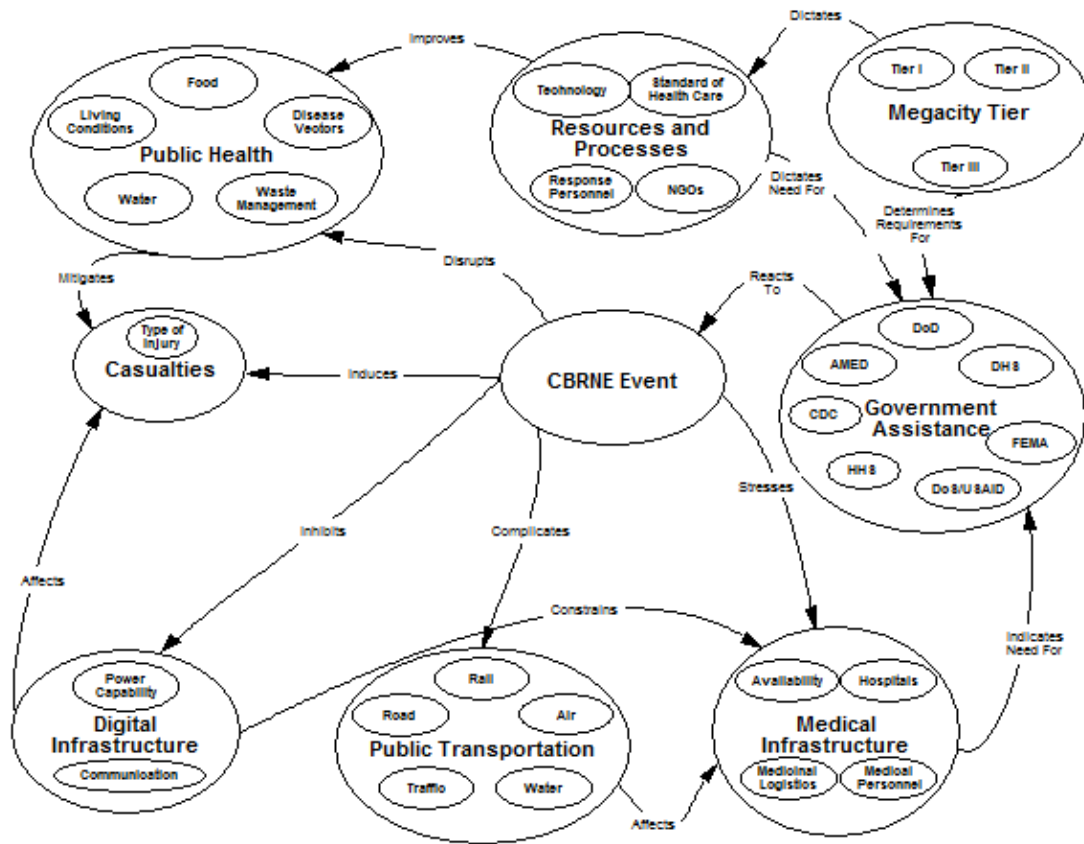

Figure 6. Medical Systemigram

The second product that contextualizes the current state of the system is an Emergency Capability Response Diagram (Figure 7). It shows the relationships between top-level functions and serves as the foundation for the assessment of the alternative solution designs. This diagram shows the succession of command which would occur in the event of a large scale nuclear attack. The arrow connecting AMEDD integration to Emergency Response Procedures serves as the purpose of this project. Our results will illustrate gaps that exist in this network, which would allow for more efficient coordination efforts between AMEDD and the PHS. These structural gaps will be laid out in detail further in the report. After the Emergency Capability Response Diagram established context through which the system operates, the Fundamental Objective was used to create a functional hierarchy of the functions required to achieve our system objectives (Parnell, 2010).

The functional hierarchy established five critical functions necessary to identify all of the structural gaps in the system. The functions are: assess the effects of a 10kt nuclear weapon on a megacity; assess other emergency agencies; assess public health systems; assess AMEDD Doctrine; and integrate AMEDD. A value hierarchy is used to measure the completeness of functions by associating value measures with each function. For example, to successfully assess emergency agencies, interviews were conducted with subject matter experts, and doctrine researched.

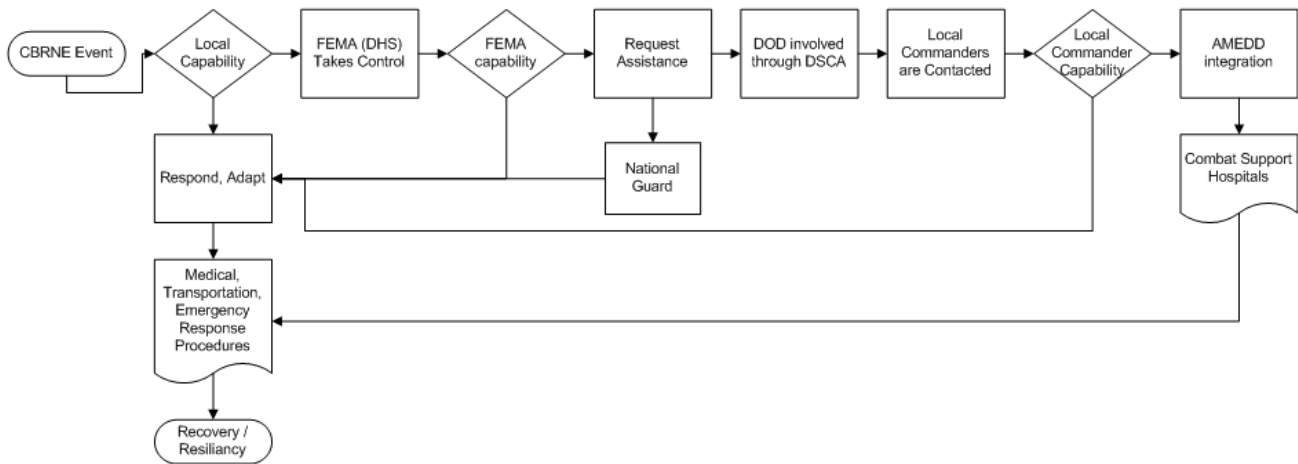

Figure 7. Emergency Capability Response Diagram

After the project plan was fully developed, subject matter expert interviews were conducted in order to fulfill the functions put forth in the functional hierarchy. The information gained allowed for recommendations which would yield a more flexible system that would inform and integrate AMEDD efforts about current medical and PHS response. Interviews were conducted with representatives from multiple organizations within New York City’s emergency response effort. The organizations include the OEM at the state and city level, the FEMA, the VA, AMEDD, and representatives from HHS. Combing the systems brings in complexity. For example, the OEM offices at the state and city level serve the same role, and therefore do not work well in conjunction with one another. The collective input received from all of the organizations regarding the emergency response system illuminated structural gaps that exist between layers of response management. These gaps decrease the overall efficiency of response through miscommunication and misguided preparation efforts.

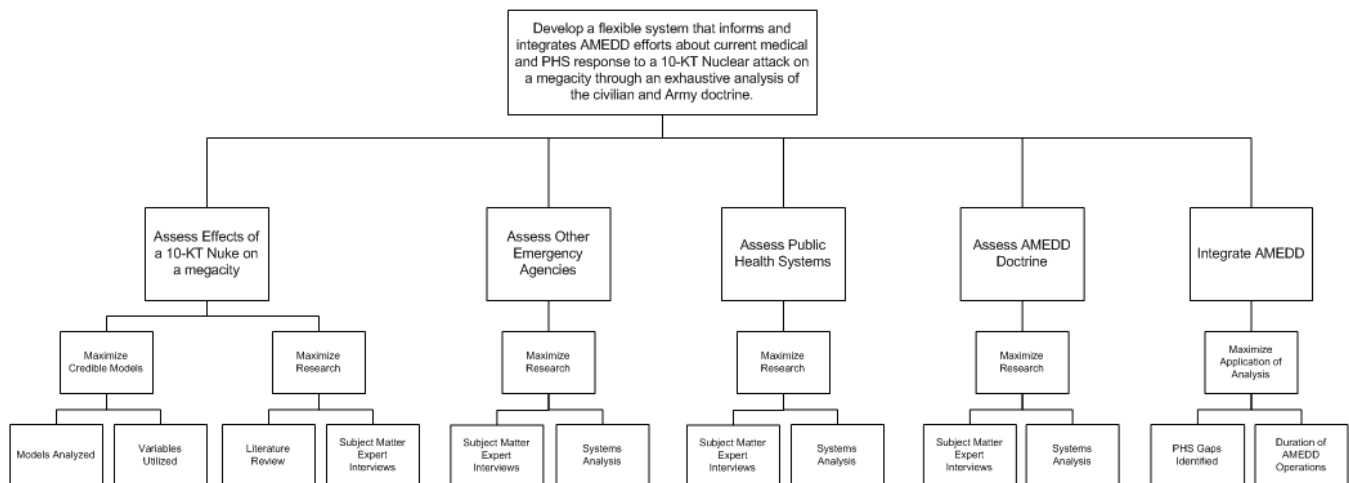

Figure 8. Functional / Value Hierarchy

Figure 9 illustrates the vulnerabilities that exist within coordinated emergency response. Each arrow corresponds to a structural gap that was identified through exhaustive analysis of the emergency response system. Sixteen gaps were found. These problems were brought to light by the interviews conducted with organizations within the system and thorough organization systems analysis. Understanding these shortcomings will assist in AMEDD integration to improve overall emergency response system effectiveness. For example, a gap that exists between the hospitals and the New York State

OEM is the use of different patient tracking systems. That is, hospital networks have their own patient tracking systems in order to best manage the movement of personnel in response to changing demands. However, the New York State OEM uses a different patient tracking system in order to track the movement of personnel across the different networks of hospitals in order to maximize bed utilization. This, however, requires hospital staff to update multiple tracking sources before movement of patients may take place. The lack of transparency between these systems leads to discrepancies between the local and state tracking systems, decreasing overall system efficiency.

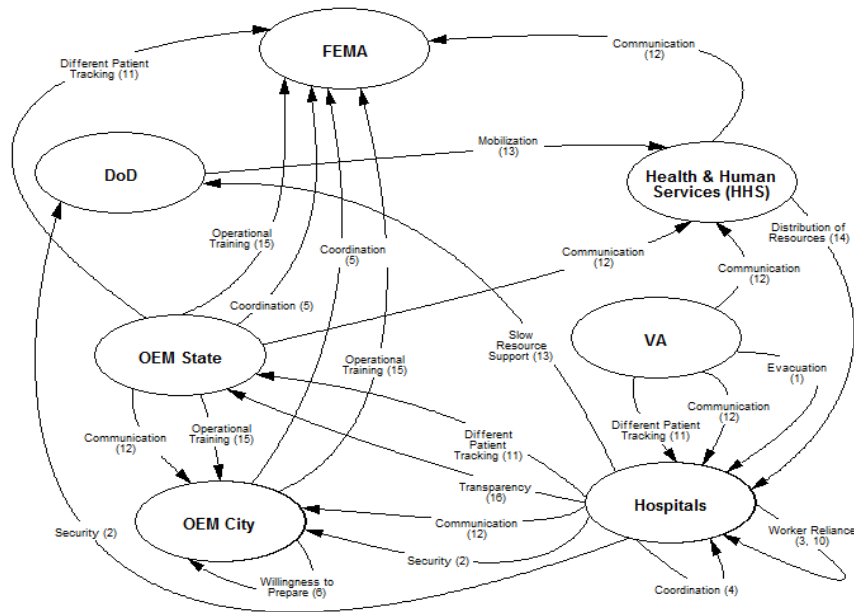

Figure 9. Gap Analysis

Figure 10 applies systems dynamics to the gaps that have been identified. Systems dynamics modeling was conducted on each of the gaps that were identified in the emergency response system. In this case, a causal loop diagram shows how the high demand for medical care in the event of a 10-kiloton nuclear attack would surpass the hospital capacity to provide care. This would increase the rate of casualties which are denied care at the hospital. As this loop is reinforced, the casualties denied care will create a growing security threat that has not yet been addressed by the emergency response system. If not addressed, this structural gap has the potential to disrupt the effective treatment of casualties.

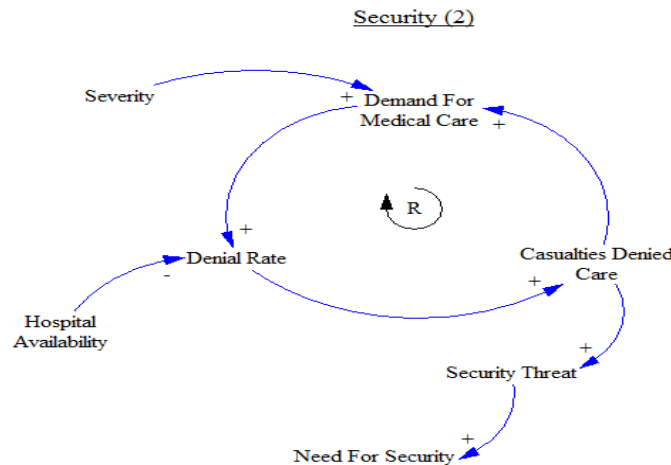

Figure 10. Systems Dynamics

5. Results

The gaps identified through an exhaustive analysis of the current emergency response system allows for an informed decision on how to best direct AMEDD resources to improve the system. They will also allow current emergency response organizations to reduce the gaps to improve overall efficiency and effectiveness which will directly improve the number of lives saved. The severe and immediate nature of a 10-kiloton nuclear attack demands that these vulnerabilities be addressed and mitigated as soon as possible. Organizations from across the emergency response structure gave valuable insights into problems that have either been identified through execution and training or problems that may be brought to light in the future. Interviews, research and on-the-ground work identified sixteen gaps that span from the need for a coordinated evacuation plan out of a densely populated city to the need for more positive working relationships between actors in the system. Analysis of these gaps will have a positive influence on international actors as well. Other megacities can model their consequence management programs off the New York City system. While other megacities may not have the resources that New York City has, they can still implement certain processes that are similar. Operating procedures like the National Response Framework (NRF), the National Incident Management System (NIMS), and the National Disaster Management System (NDMS) should serve as frameworks for structuring consequence management programs based off of available resources. The identification of these gaps is a critical first step in building a resilient emergency response system that is prepared for execution.

Gap	Importance	Effect
Evacuation	-Getting Casualties to Medical Care	-Increased Casualties
Security	-Stabilization	-Prolonged Instability -Increased Casualties
Worker Reliance	-Hospital Readiness	-Prolonged Instability -Increased Casualties
Coordination Among Hospitals	-Ensure Casualties Receive Treatment	-Prolonged Instability -Increased Casualties
Coordination Between Federal and Local Authorities	-Ensure Casualties Receive Treatment	-Inefficient Response
Lack of Willingness to Prepare	-Efficient Response Ready	-Prolonged Instability -Increased Casualties
Reliance on Electronics	Vulnerable to an EMP Strike	-Inefficient Response
Patient Tracking	-Assess Hospital Availability	-Prolonged Instability -Increased Casualties
Communication Implications	-Assess Hospital Availability -Track Patient Location	-Inefficient Response
DOD is Slow to Mobilize	-Casualties Treated in Timely Manner	-Prolonged Instability -Increased Casualties
PHS has no Formal Authority Structure	-Creates Order within Response Structure	-Inefficient Response
Lack of Realistic Operational Training	-Efficient Response Ready	-Prolonged Instability -Increased Casualties

Figure 11. Gap Analysis Table

Figure 11 provides a summary of all of the gaps identified in the system. The table is broken down into the gap, importance and effect. Many of the gaps, if not addressed, will have the same effect on the system. For example, if a 10 kt nuclear event happens in New York City, two gaps identified in the system are the ability to get security at the medical facility and PHS’ ability to track patients. It is critically important for the local police department to stabilize the situation as much as possible. Hospitals will inevitably have to start turning people away when they reach maximum capacity. This will create a hostile environment where people will likely act irrationally to try and get medical care for themselves or their loved ones. There is also the potential for terrorist organizations to take advantage of the chaotic situation. It is also important to track patients so that individuals outside of the city can check on the status of their loved ones. Hospitals also need that information so they know if the facility that they are transferring patients too actually has available. While the two gaps are different, they will have equal impacts on the system. Not being able to secure the site will only prolong the amount of time that the city is destabilized. The longer it is destabilized the less people will trust the city’s ability to respond, thus creating a

snowball effect where it will only become more difficult to respond. In addition to being destabilized, more and more people may die. Without structure, there is the potential for people with nefarious intentions to gain from the chaos by inflicting damage on helpless individuals. Similarly, if patients are being transferred to hospitals with no availability, they will not receive the treatment and care they need and may have to be transferred more times thus extending the time without care while increasing the likelihood of death. This same logic applies to almost every gap which emphasizes the severity of this research. The outcome of almost all of these gaps, if not addressed, is more people dying.

6. Conclusion

DOD and their federal affiliates identified a need for thorough understanding of the second and third order effects of a CBRNE event within a megacity. It is essential to understand all of the implications in order to develop a response structure across all levels of a society to reduce the number of casualties and instability created by such an event. This research served to identify gaps within the PHS response. During the exhaustive analysis of PHS and the organizations within it and working with it, two major themes emerged. The first was the complexity that this problem holds. In order to fully prepare for an attack of this scale, damage assessment needs to be done through the lens of each of the five types of CBRNE categories on their own, rather than trying to study CBRNE as a whole. Secondly, the implications of this research is incredibly significant. Many of the gaps within the PHS' response lead to more people being left untreated and potentially dying.

To properly address this project, an exhaustive analysis of a megacity's medical systems response a CBRNE event was conducted. The scope had to be limited because CBRNE events all have different implications and thus warrant different responses. The research was limited to studying the implications of a 10 kt nuclear event on the system because such an event would most likely thoroughly shock the whole system. This was a critical part of the research. The different tiers of megacities also made the problem difficult to grasp. A mature megacity like New York would react significantly different than an emerging one, like Lagos, Nigeria. New York City became the case study because its vast resources would give a better idea how a megacity should respond and the close proximity to the research site made it practical to visit. The gaps and inefficiencies were analyzed knowing that conclusions needed to be made that would be applicable to megacities around the world. Finally, the response is framed by the specific context surrounding the individual CBRNE event. If the event happened on a particularly windy day then considerably more people would be affected by the radioactive fallout. It was beyond the scope of this project to address how the event would impact critical infrastructure. For example, would the event take out a major bridge that would add another variable to the city's ability to respond effectively? All of these unknowns make it incredibly difficult to quantify variables and construct credible models which are a key part of developing a resilient system without having the real event occur.

The complexity of the global situation also adds to the implications of a CBRNE attack in a megacity. Since nations and uniformed soldiers do not exclusively wage conflict, it is incredibly challenging to predict where an event may occur. Nations like Iran and North Korea combined with terrorist groups like ISIS and Hamas have demonstrated hostile intent towards the U.S. and its allies. Access to nuclear weapons would significantly increase the reality of actually having to respond to a nuclear attack in the future. The issue is that one of the most advanced megacities (New York City) and the most powerful army (U.S. Army) in the world are not adequately prepared to respond. Representatives from the FEMA, the OEM City, the OEM State, Memorial Sloan Kettering, etc. expressed concerns about their organizations and New York City's ability to coordinate efforts across all levels of response. Any hiccup in response results in a failure to bring casualties to medical care, which means more people will die. The analysis, unfortunately, indicated that if New York City faced an event such as a 10 kt nuclear explosion, a lot of people would die due to gaps in the PHS system. In the aggregate, the data summary identifies 12 operational gaps whose effect leads to prolonged instability and increased casualties.

This research serves as a foundation for further analysis. The first step in creating a system that is prepared to respond effectively is identifying the flaws. However, that cannot serve as a standalone analysis or else the problems will continue to exist. It is highly important for the appropriate agencies to take this research and build upon it in a way that can be applied to megacities across the world. The task is highly complex, but if completed correctly will save countless lives.

7. Acknowledgement

Parts of this paper were previously published and presented in the Donald R. Keith Memorial Capstone Conference at USMA in May of 2016.

8. References

- 20th CBRNE. (2016). *20th CBRNE Mission Statement*. Retrieved from 20th CBRNE: <http://www.cbrne.army.mil/>
- Agency, D. T. (2015). *Who We Are*. Retrieved from Defense Threat Reduction Agency: <http://www.dtra.mil/About/WhoWeAre.aspx>
- Barash, P. G., Cullen, B. F., Stoelting, R. K., Cahalan, M., & Stock, M. C. (2011). *Clinical Anesthesia*. New York: Lippincott Williams and Wilkins.
- Barrett, C. B. (2013). *Food Security and Sociopolitical Stability*. Oxford: Oxford University Press.
- Betts, R. (2012). The New Threat of Mass Destruction. *Foreign Affairs*, 26-41.
- Bupose, C. F., Burton, J., & Smoak, E. (2015). CBRNE Task Force. *CML Army Chemical Review*.
- Campbell, C. C. (1991). Food Insecurity: A Nutritional Outcome or a Predictor Variable? *The Journal of Nutrition*, 408-415.
- Cargill. (2016). *Good Security: Solutions and Responses*. Retrieved from Cargill: <http://www.cargill.com/corporate-responsibility/food-security/solutions-responses/index.jsp>
- Caves, J. P., & Carus, W. S. (2014). *The Future of Weapons of Mass Destruction: Their Nature and Role in 2030*. Washington, D.C.: National Defense University Press.
- Chairman of the Joint Chiefs of Staff. (2012). *Joint Publication 3-41: Chemical, Biological, Radiological and Nuclear Consequence Management*. Washington, D.C.: Department of Defense Joint Staff.
- Command, J. F. (2007). *Joint Operating Environment: Trends and Challenges for the Future Joint Force Through 2030*. Norfolk: Joint Forces Command.
- Company, M. a. (2002). *FDNY McKinsey Report - Increasing FDNY's Preparedness*. Retrieved March 15, 2016, from NYC.gov: http://www.nyc.gov/html/fdny/html/mck_report/toc.html
- Cordesman, A. H. (2001). *Radiological Weapons as Means of Attack*. Washington, D.C.: Center for Strategic and International Studies.
- Department of the Army. (2005). *FM 3-11.5: Multiservice Tactics, Techniques, and Procedures for Chemical, Biological, Radiological and Nuclear Decontamination*. Washington, D.C.: Department of the Army.
- Department of the Army. (2014). *ATP 3-11.24 - Technical Chemical, Biological, Radiological, Nuclear, and Explosives Force Employment*. Washington, D.C.: Department of the Army.
- Garvelink, W. J., & Wedding, K. (2013, February 21). *Nutrition and Food Security in the City*. Retrieved from CSIS - Center for Strategic and International Studies: <https://www.csis.org/analysis/nutrition-and-food-security-city>
- GlobeScan, & Hazel, M. M. (2007). *Megacity Challenges: A Stakeholder Perspective*. Munich: Siemens.
- Haering, S. A., & Syed, S. B. (2009). *Community Food Security in the United States Cities: A Survey of the Relevant Scientific Literature*. Baltimore: Johns Hopkins Center for a Livable Future.
- Harris, M., Dixon, R., Melin, N., Hendrex, D., Russo, R., & Bailey, M. (2014). *Megacities and the United States Army: Preparing for a Complex and Uncertain Future*. Washington, DC: Chief of Staff of the Army.
- Heffelfinger, D. G., Tuckett, C. M., & Ryan, J. R. (2013). The Military's Response to Domestic CBRNE Incidents. *Journal of Homeland Security and Emergency Management*, 57-75.
- Historical Department, C. (2007, April 23). *Terrorist CBRN: Materials and Effects*. Retrieved from Central Intelligence: https://www.cia.gov/library/reports/general-reports-1/terrorist_cbrn/terrorist_CBRN.htm
- Jindal, A., & Roy, K. (2014). Bio-threat Preparedness: Need for a Paradigm Shift. *Medical Journal Armed Forces India*, 170-174.
- Johns Hopkins School of Public Health. (2016, May 10). *Food Distribution and Transport*. Retrieved from Johns Hopkins Bloomberg School of Public Health: http://www.jhsph.edu/research/centers-and-institutes/teaching-the-food-system/curriculum/distribution_and_transport.html
- Kelley, M. (2012). *Terrorism and the Growing Threat of Weapons of Mass Destruction: Al-Shabaab*. Charles Town: American Military University.
- Kelly, C. (1995). Assessing Disaster Needs in Megacities: Perspectives from Developing Countries. *GeoJournal*, 381-385.
- Khan, O. A., & Pappas, G. (2011). *Megacities and Global Health*. Washington, D.C.: American Public Health Association.
- Kollek, D., Welsford, M., & Wanger, K. (2009). Chemical, biological, radiological and nuclear preparedness training for emergency medical services providers. *Canadian Journal of Emergency Medicine*, 337-342. Retrieved from Center for Excellence in Emergency Preparedness: <http://www.ceep.ca/publications/emscbrn.pdf>
- Kraas, F. (2007). Megacities and Global Change: Key Priorities. *The Geographic Journal*, 79-82.
- Krieger, K., Amlot, R., & Rogers, M. (2014). Understanding Public Responses to Chemical, Biological, Radiological and Nuclear Incidents - Driving Factors, Emerging Themes and Research Gaps. *Environmental International*, 66-74.
- Lorrain, D. (2014). *Governing Megacities in Emerging Countries*. Burlington: Ashgate Publishing Company.
- McDonald, B. L. (2010). *Food Security*. Cambridge: Polity Press.

- Murray, M. J. (2013). Emergency Preparedness for and Disaster Management of Casualties from Natural Disasters and Chemical, Biologic, Radiologic, Nuclear and High-Yield Explosive (CBRNE) Events. In N. T. Dernoski, *Clinical Anesthesia* (p. 895). Philadelphia: Lippincott, Williams and Wilkins.
- New York City. (2016). *NYC - Planning - NYC Population*. Retrieved from NYC: <http://www1.nyc.gov/site/planning/data-maps/nyc-population/current-future-populations.page>
- New York City. (2016). *NYC Health + Hospitals*. Retrieved from NYC: <http://www.nychealthandhospitals.org/hhc/html/about/About-HospServices-HHC-Facility-List-Hospitals.shtml>
- Obono, O. (2007). A Lagos Thing: Rules and Realities in the Nigerian Megacity. *Georgetown Journal of International Affairs*, 31-37.
- Parker, D., & Tasell, S. (1995, November). Hazard Transformation and Harzard Management Issues in the London Megacity. *Geo-Journal*, pp. 313-328.
- Parnell, G. S., Driscoll, P. J., & Henderson, D. L. (2010). *Decision Making in Systems Engineering and Management*. New York: John Wiley and Sons.
- Porter, J., Dyball, R., Dumaresq, D., Deutsch, L., & Matsuda, H. (2014). Feeding Capitals: Urban Food Security and Self-provisioning in Canberra, Copenhagen and Tokyo. *Global Food Security*, 1-7.
- Reichart, J. F., & Caves, J. P. (2014). *The Future of Weapons of Mass Destruction: Their Nature and Role in 2030*. Washington, D.C.: National Defense Univeristy Press.
- Rosner, D., & Markowitz, G. (2006). *Are We Ready? - Public Health Since 9/11*. Oakland: The University of California Press.
- Rossenfeld, C. (2015). *The Energy from a Nucelar Weapon*. Retrieved from Atomic Archive: <http://www.atomicarchive.com/Effects/>
- Sandstrom, B. E., Erkksson, H., Norlander, L., Thorstensson, M., & Cassel, G. (2014). Training of Public Health Personnel in Handling CBRN Emergencies: A Table-Top Exercise Card Concept. *Environmental International*, 164-169.
- Smith, L. A., El Obeid, A. E., & Jensen, H. H. (2000). The Geography and Causes of Food Insecurity in Developing Countries. *Agricultural Economics*, 199-215.
- Tree, T. (2014, April). *Food Insecurity and Unrest in the Arab Spring*. Retrieved from E-International Relations Students: <http://www.e-ir.info/2014/09/07/food-insecurity-and-unrest-in-the-arab-spring/>
- United States Congress House Committee on the Budget. (1990). Hearing: Hospitals in Crisis: Financial Impact of AIDS on New York City's Hospitals . In U. Congress, *Hearing: Hospitals in Crisis: Financial Impact of AIDS on New York City's Hospitals* (p. 88). Washington, D.C.: US Government Publishing Office.
- Wallerstein, A. (2016, May 21). *New York City 10kT Event*. Retrieved from NUKEMAP: <http://nuclearsecrecy.com/nukemap/>
- Watts, J. (1999). Tokyo Terrorist Attack: Effects Still Felt 4 Years On. *The Lancet*, 569.
- World Bank Group Team. (2009). *Framework Document for a Global Agriculture and Food Security Program: Sustainable Development Network*. Retrieved from GAFSP - The Global Agriculture and Food Security Program: <http://www.gafspfund.org/sites/gafspfund.org/files/Documents/GAFSP%20Framework%20Document%20FINAL%20%28external%29.pdf>
- Yeskey, M. K. (2010, July 22). The Key Role of NDMS in Disaster Response. (C. o. Affairs, Interviewer)